

EVO

EVOSTONE TECHNICAL MANUAL



CONTENTS

PRODUCT	
Safety	2
Available Sizes	3
HANDLING AND STORAGE	
Handling	4
Storage	5
DESIGN AND PRODUCTION	
Preparing a Plan and Clearance	6 - 7
Supports	8
Overhangs	9
FABRICATION	
Joining	10
Machining and Cut-outs	11
Under-mount Sinks and Finished Edges	12
Refinishing	13
Repairs	14
Fabrication Check	15
INSTALLATION	
Securing Evostone	16
Cook-tops, Sinks and Dishwasher / Dryers / Washing Machine	17
SPLASHBACK	
Cooktop Clearance	18
Installation Guidelines and References	19

PRODUCT

OVERVIEW

Evostone is supplied with a prefinished semi-gloss surface and edges. It is a condition of the Evostone 10 Year limited warranty that before any fabrication or installation work is commenced, the Evostone sheet condition is fully inspected for batching, colour matching issues or imperfections.

DO NOT INSTALL EVOSTONE OUTSIDE, INTERIOR USE ONLY.

SAFETY

Before working with Evostone, an adequate risk assessment must be carried out. All steps must be taken to minimize any risks to health and safety. Appropriate industry standard safety equipment such as dust masks and eye protection should be worn at all times when working with the product.

Machinery and tools require sufficient dust extraction and good ventilation to the work area.

AVAILABLE SIZES

Evostone is available in 20mm thick slab in 3 formats:



3600 x 610mm
85KG

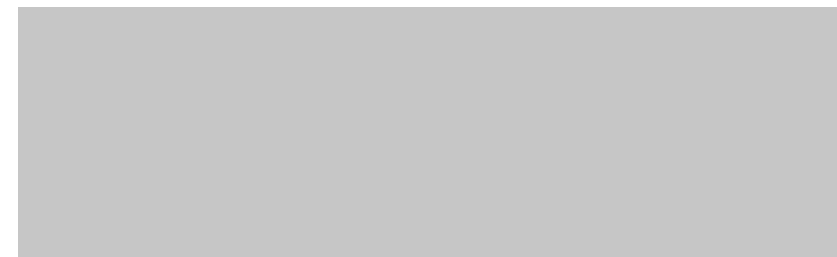

3050 x 900mm
105KG

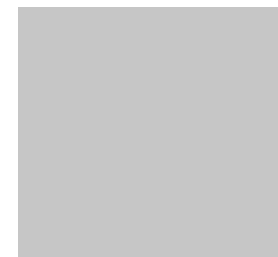

1000 x 900mm
34KG

HANDLING AND STORAGE

HANDLING

Evostone slabs must be handled in a safe manner by either mechanical, such as a forklift or manual lifting by multiple people.

Do not attempt manual lifting of multiple slabs.

Slabs handled by forklift must have a supporting pallet when lifting.

When manual lifting, a slab must be lifted to a vertical position with bottom edge remaining completely in contact with supporting surface then raised. To lower the slab, place the bottom edge on the supporting surface or the back of the sheet against a bench then rotate to a horizontal position keeping the edge or back in contact with supporting surface.

STORAGE

Evostone must always be stored indoors. Transporting sheets must be packed with a 16mm bottom packing sheet and a suitable cover sheet. The package to be then placed on bearers no more than 600mm apart and support the full width of the sheet (max 10 sheets sheet) and loaded on a flat surface. Tie down straps must be placed directly over the bearers and no goods to be

loaded on top of the sheets. For long term storage or large volume(10+sheets) the sheets must be placed on a pallet with support along the full length with minimal opening for forklift tines and a minimum of 3 points of support in depth.

Do not store on edge

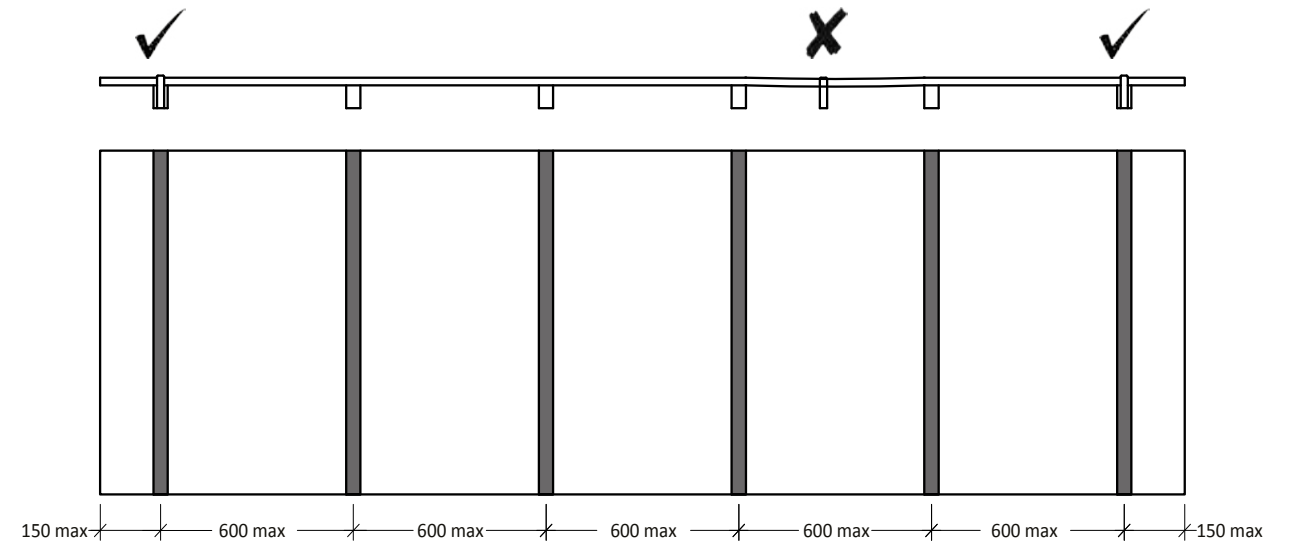

DESIGN AND PRODUCTION

PREPARING A PLAN

Prepare a plan for your layout. Joins should not be made over a dishwashers, washing machine, washer dryer or any other appliance which will produce heat. Joins must be 75mm away from cut-outs. Joins are to be fully supported and not over benchtop overhang.

CLEARANCE

Freestanding cookers must be installed so the level of the hob is not below the benchtop and allow clearances as recommended by the appliance manufacturer or a minimum of 2mm, whichever is the greatest.

Cooktops must be installed with the heat reflective tape kit and the cooktop gasket. Direct contact will result in damage.

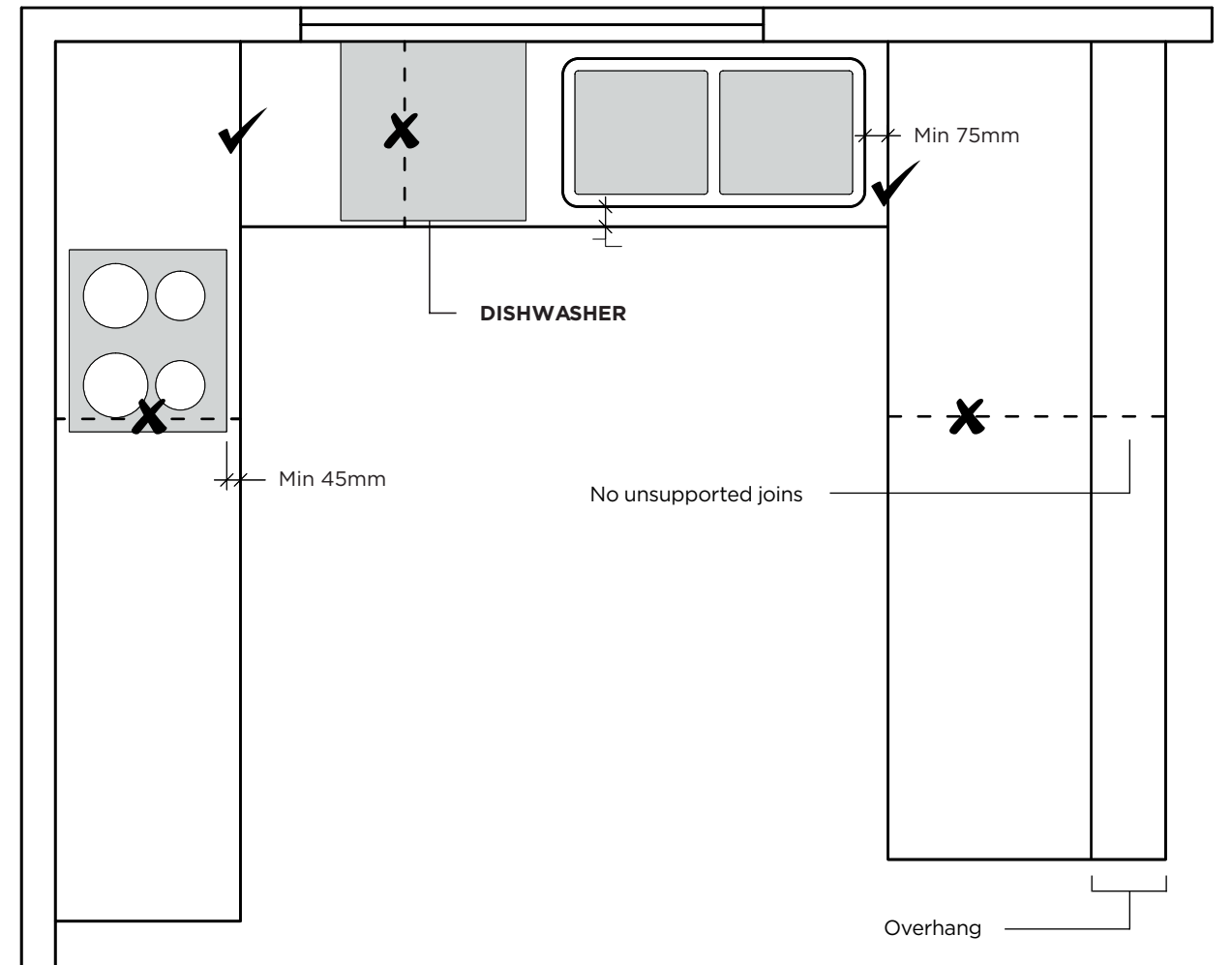

SUPPORTS

Evostone is required to be adequately supported. Spans that exceed 600mm must be supported along the front by using the Evostone structural aluminium support rail, available from your local distributor. The structural rail is limited to a maximum span of 1200mm when installed in

a vertical position and 1000mm in a horizontal position. Rail is fastened by pre-drilling countersunk holes in ends to suit rail and screwed into position. Tip: Use a 20-30mm offcut clamped into position on cabinet end and drill required screw holes.

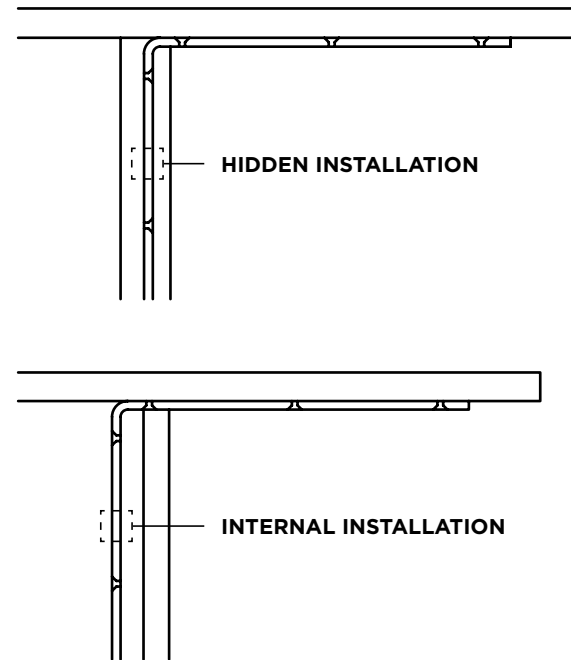
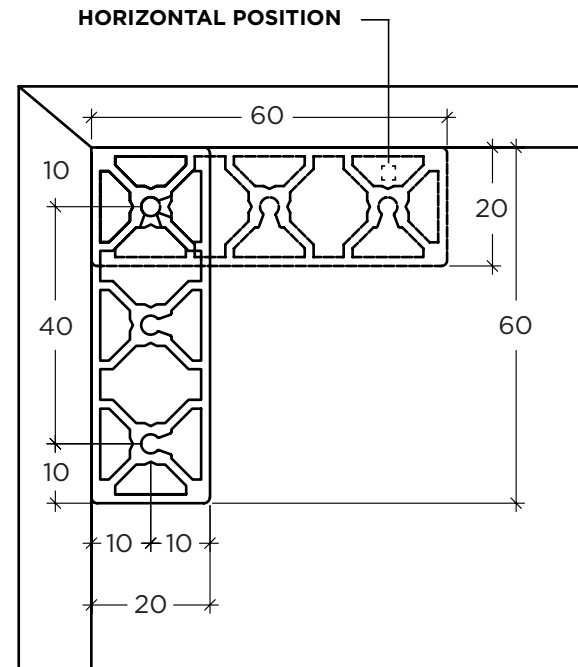

OVERHANGS

Unsupported overhangs such as breakfast bar areas must not exceed 150mm. If a overhang is to exceed this, support is required in the form of structural material such as plywood or the use of Evostone support bracket. Overhangs must not exceed 300mm.

between the back panel and cupboard back or screwed on the inside of the cupboard. It can also be housed flush to the underside of the benchtop and shortened to suit desired application.

Spacing of bracket must not exceed 900mm and 300mm from the end of the benchtop.

Support bracket can be installed completely hidden

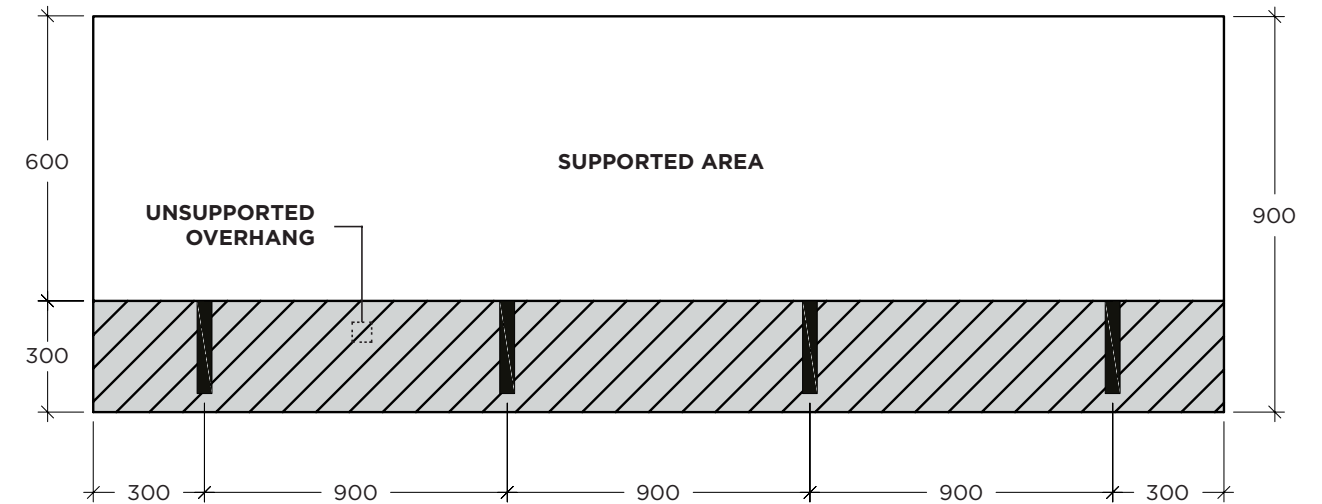

JOINING CLASSICS

Because of the consistent pattern on these boards end butt joints (to make longer tops), waterfall ends, and 90° corner joints are all possible using our recommended joining method and are covered by our warranty. Side joints (to make wider tops) can be attempted by fabricators using the “seamless” method. The outcome is determined by the skill or craftsmanship of the fabricator as mentioned these joints are outside our warranty. It is intended to utilise the sheets in the widths available to reduce fabrication.

Checking for batch matching sheets and a visual inspection of sheets is a prerequisite before joining sheets.

JOINING ELEMENTS

Elements range are hand produced create a unique pattern for each individual sheet. Because of the inconsistent pattern on these boards only 90° corners are recommended, using our joining process and covered by our warranty. All other joints can be attempted however, because of the uniqueness of every board it is

unlikely both the vein and base colour will align/match therefore these types of joints are outside our warranty. It is intended to utilise the sheets in the sizes available to reduce using fabrication.

Checking for batch matching and a visual inspection of sheets is a prerequisite before joining sheets.

MACHINING

Machining Evostone will cause dust particles and it is important that the work area is well ventilated and adequate dust mask and eye protection is worn. All machinery and tools should be fitted with dust extraction equipment. Dust extraction on random orbital sander is important not only for removing dust but will achieve a better finish. It should be noted that Evostone contains **NO CRYSTALLINE SILICA.**

- Evostone can be machined using CNC Machines but also simple tools such as:
- Sliding Table Saw with a negative rake blade
- Plunging Circular saw with fine tooth or solid surface blade

- 1/2 inch Router with Tungsten Carbide bits (5mm deep passes)
- Jigsaw with fine tooth blade
- Hole cutters

There are many solid surface cutting blades available which will produce a cleaner cut and longer life. Check with you local tool supplier for availability and information.

CUT-OUTS

Common internal cut-out such as sinks, cooktops and tap holes are to be a minimum of 75mm from any joint, 45mm from the front edge for cooktops and 65mm for sinks. See Design and Production. Internal cut-outs require a minimum of 10mm radius corners and have a 3mm radius on the top and bottom edge. Cut-outs should be free of any jagged edges and sanded or routed smooth. Cooktop cut-outs require the Evo Cooktop Install Kit applied to the internal edge to protect the surface from any heat. See Installation.

Mark out desired cut-out using masking tape and pen. The tape will help protect the surface and make it easier to see cut lines. To machine cut-out, drill a 20mm

minimum diameter hole in each corner. Use a guide rail or template with a 1/2 inch router or plunge cut saw along the straight line. Use multiple 5mm deep passes with a router. A plunge cut saw will not be able to cut the full depth of the cut line in the corners. Use a jigsaw to finish.

UNDERMOUNT SINKS

Undermount sinks are achieved by cutting out the required cut out leaving a 5mm trim to finish line using plunge cut saw or jigsaw and trimming the finished cut out to size using a jig and 1/2 inch Router. Polish the inside of cut-out. Adhere sink in place using a high bond strength silicone suitable for wet areas. Glue additional Evostone blocks to underside with a rebate for the sink edge or suitable clamps supplied using the Evostone glue.

FINISHED EDGES

End cuts that require a polished edge can be achieved by using an orbital sander to sand the edge, working through sanding from 120 grit up until a polished finish and edge profile is achieved. Clean between grit levels.

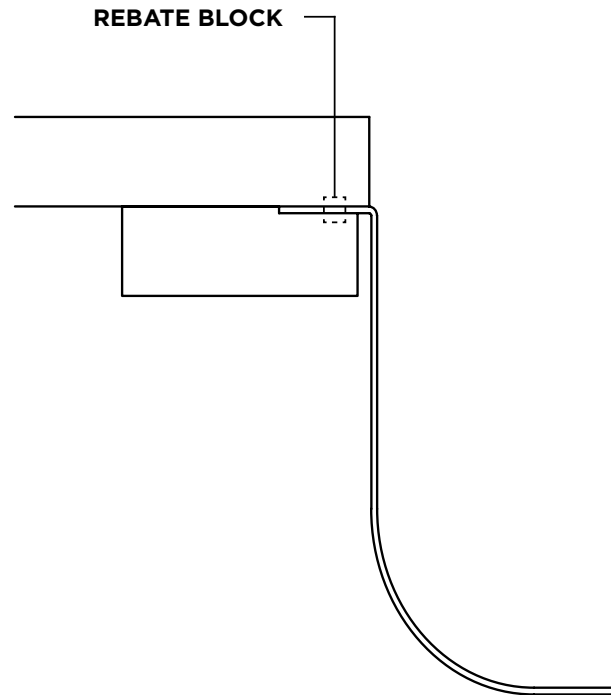

REFINISHING

Evostone product has the ability to be refinished and even completely repaired. The following outlines general procedures. Minor marks or scratches can be removed using a non scratch scourer pad and soapy water.

To refinish the surface, evenly sand surface using a random orbital sander. Ensure proper dust extraction equipment is used with the orbital sander. Recommend using a Festool Rotex Sander and Festool Dust Extraction unit. Use a minimum of 150mm diameter sanding pads.

Depending on the surface condition finish, start at the finest grit that will remove marks and work through finer grits until required finish is achieved.

When sanding, alternate the direction and sand in a circular motion overlapping the previous pass. The surface must be wiped clean between each grit level using a clean cloth and denatured alcohol.

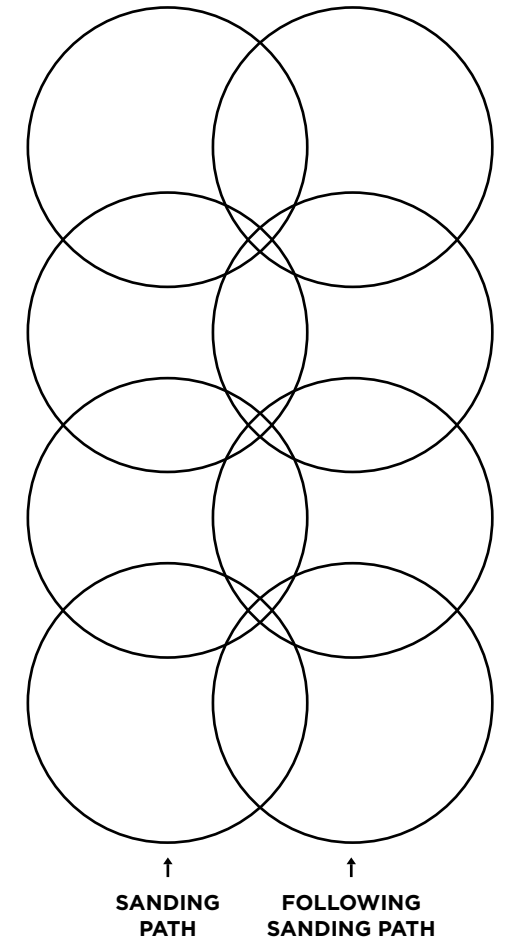

REPAIRS

In the event damage has occurred to the surface due to improper use or installation cracks and chips can be repaired. A good practice is to supply cut out to clients so they have matching batch piece to use for repairs.

Small chips can be repaired by making a tapered round plug. Then using a router and jig to router out a matching hole for the plug to fit into. Example below.

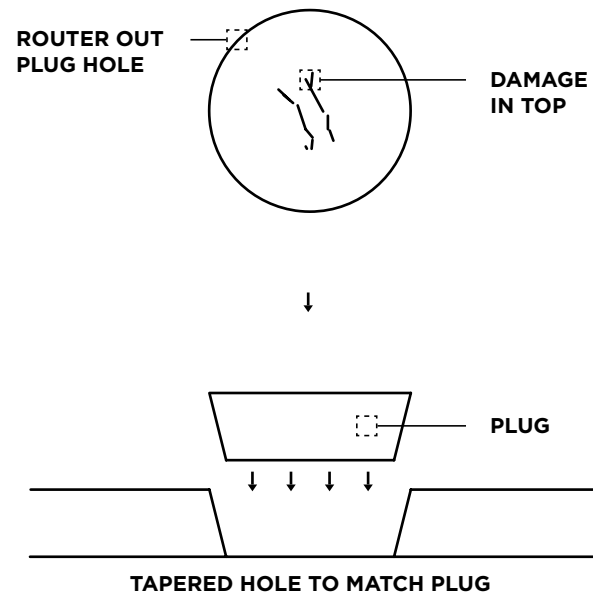

For cracks in the edge of tops, machine a curve shape completely removing crack. Example below.

Apply adhesive and press or clamp replacement piece in place. Allow to cure and refinish top. Refer to "REFINISHING"

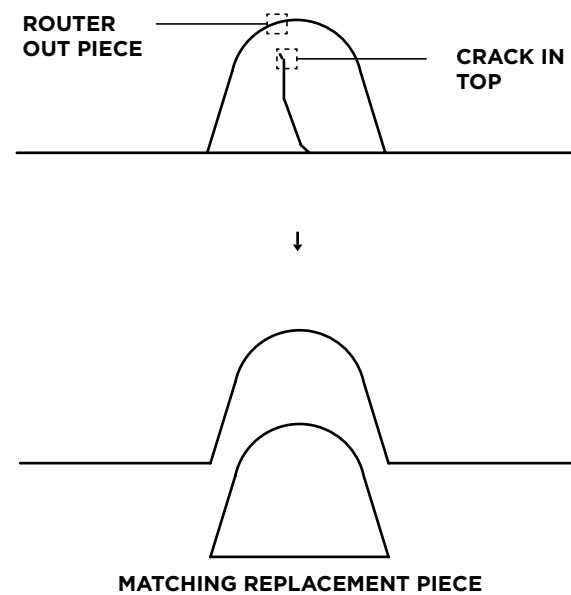

PREFABRICATION CHECK

Before beginning production, visual inspection of the sheet for possible imperfection, colour variation, matching batch numbers or transport damage is required by customer.

BATCH NUMBERS

Batch numbers are used for reference to the production run of the stock. Batch numbers are located on the back of the sheet as in the following example. The batch number relates to the quality control (QC) date of inspection and the production number. example "2506213223" is QC date 25/06/21 and production number 3223. This is a simple reference to know a specific colour boards were produced together and when. While reference number are good check for colour match a visual inspection is a prerequisite before joining commences.

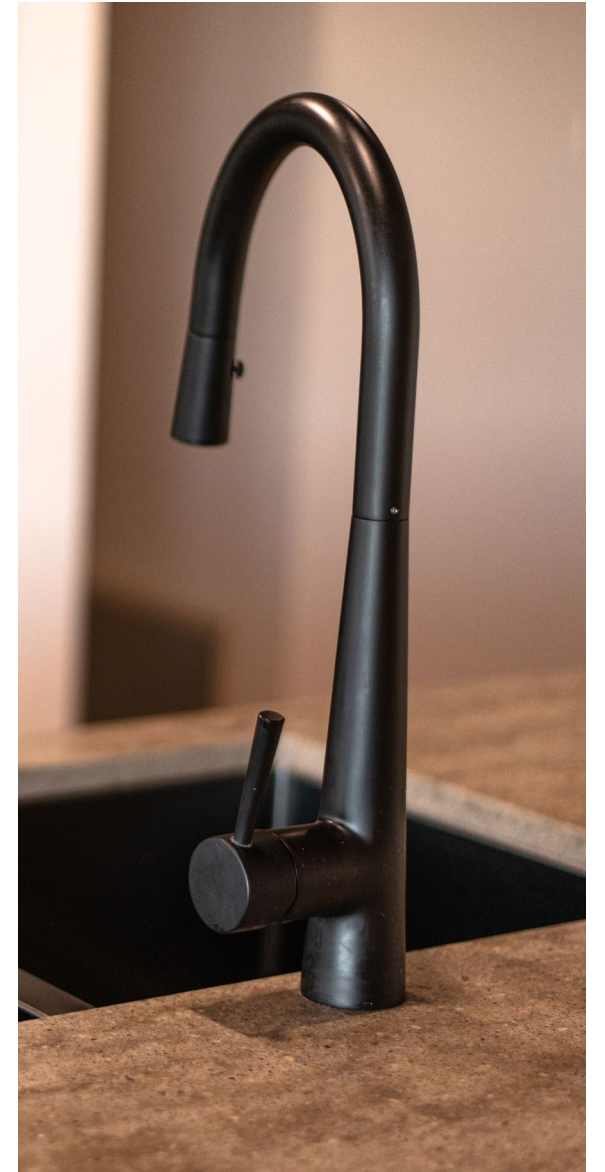

INSTALLATION

Evostone is to be installed on a level and solid foundation. Cabinets should be installed correctly making a solid base and fixed securely into place. Allow time for the material to meet room temperature prior to installation.

The Evostone must be fitted to the wall allowing a minimum of 1mm expansion per metre of material.

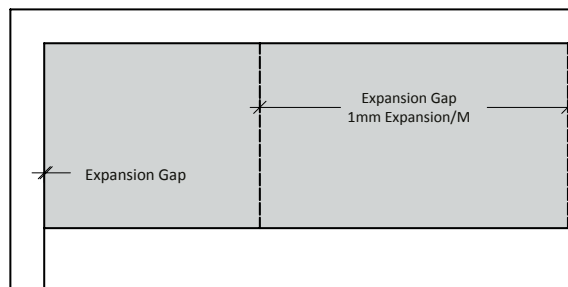

To secure evostone, apply liberal dabs of silicone every 150-200mm to the top edges of the cabinets. Support the Evostone when lowering into position.

DO NOT SCREW INTO EVOSTONE.

When joining Evostone slabs and waterfall ends, arras and polish the cut edge to match the finished edges. Sand the unseen edge section with course grit for a better bond.

Using a lamella style biscuit or equivalent will aid in maintaining a more flat and precise join.

Apply 'Evostone Acrylic Adhesive' (available from your Evostone Distributor) to the bottom $\frac{2}{3}$ 'd of the thickness just short of the front edge and then apply silicone to the remaining top $\frac{1}{3}$ 'd of the join edge and down front edge. Recommend using a permanetly flexible silicone. Clamp together using suction clamps, ensure a complete silicone seal and clean away any excess.

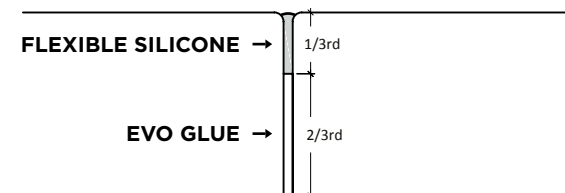

Allow time for the Evostone acrylic adhesive to fully cure. 30 Minutes in warmer climates and up to 45 minutes in cooler climates.

COOKTOPS

Cooktops cut-outs must have the heat reflective tap kit to be installed. Allow 5mm extra width and depth for the

kit. Measure the total length of the cut-out edge and trim foil to suit. Place the adhesive side up and remove the adhesize protection and stick the fiberglass felt leaving a 10mm strip of foil adhesive. Starting at the centre of the wall side of the cooktop cut-out, fold and stick the 10mm foil strip wrapping it over the topside of the cut-out 4mm. Allow the foil to hang down in cupboard.

Do not install cooktop without the foam gasket supplied with the appliance.

SINKS

Some sinks will be supplied with clips suited to thicker material. To fix this, place Evostone blocks using Evo glue or silicone MDF blocks to the underside at the clip locations.

DISHWASHER / DRYERS / WASHING MACHINES

The heat from the appliances may cause damage. Abide by the recommended appliance ventilation and install a melamine panel above such appliances.

ELECTRIC AND INDUCTION COOKTOPS

For both freestanding or bench mounted electric or induction cooktops, it is a requirement to have a minimum 50mm gap from the back edge of the cooktop to the Evostone splashback.

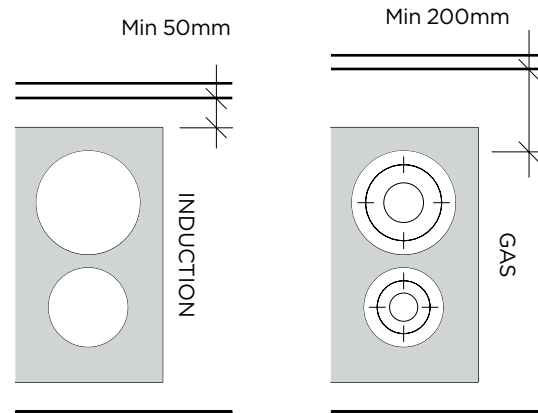

GAS COOKTOPS

For freestanding or bench mounted gas cooktops it is a requirement for a minimum 200mm gap from the periphery of the gas burner to the Evostone splashback in accordance with AS/NZS 5601 Gas Installations.

Items such as utensil racks can be fixed to a Evostone splashback. Fixing holes should be drilled using either standard hole saws or standard drill bits with no hammer action. Drill holes 1mm bigger than plastic plugs chosen and use Evostone adhesive to glue plug into place. If the holes are located close to a corner, leave at least 100mm distance between the hole and the edges.

We recommend the use of neutral cure flexible silicone for bonding the splashback to the wall cladding and neutral cure coloured silicone for sealing the joints

INSTALLATION GUIDELINES

- Timber framed wall construction should use fibre cement or plaster sheeting behind Evostone splashback applications.
- Brick wall construction should be free from loose debris behind Evostone splashback applications.
- "L" shapes should not be fabricated in one solid piece as this does not allow for movement due to thermal expansion.

When designing or installing splashback applications, designers & fabricators must always follow the relevant Australian & New Zealand standards in regard to clearances especially behind cook tops.

REFER TO

- AS/NZS 5601 Gas Installations
- AS/NZS 4386.2 Domestic Kitchen Assemblies
- Cooktop and appliance manufacturers specific installation guidelines.
- All wall and other construction methods should be as per relevant industry guidelines and building codes.

Cut outs for items such as power points should be core drilled to produce a 10mm radius internal corners.

DISCLAIMER

Under our policy of continuous product development, product specifications may change without notice. Prospective purchasers should therefore check with the retailer to ensure this publication correctly describes the products being offered for sale. All information supplied is to be used for general reference purposes only and is on the understanding that Evolution Hardware PTY LTD will not be liable for any loss, liability or damage of whatever kind arising as a result of any reliance upon such information. All pictures used in the guide are for illustrative purposes only.

Evolution Hardware PTY LTD has presented this information in good faith to all their retailers and distributors to convey before any/all purchase/s. Information is supplied upon the condition that the person/s receiving the information will make their own determination as to its suitability for their purpose/s prior to use. In no event will Evolution Hardware PTY LTD be responsible for damages of any nature whatsoever resulting from the use of, or reliance upon, information from their website or the products to which the information refers.





EVOSTONE.COM.AU

SILICA FREE

SOLID SURFACE

GO TO OUR WEBSITE TO SEE OUR FULL LIST OF
EVOSTONE DISTRIBUTORS IN YOUR AREA

EVO